



Rijksdienst voor het Cultureel Erfgoed
*Ministerie van Onderwijs, Cultuur en
Wetenschap*

Linked Data Platform @ the Cultural Heritage Agency of the Netherlands (RCE)

Date: Sep 12th 2018

Joop Vanderheiden

why

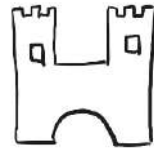
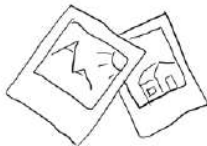
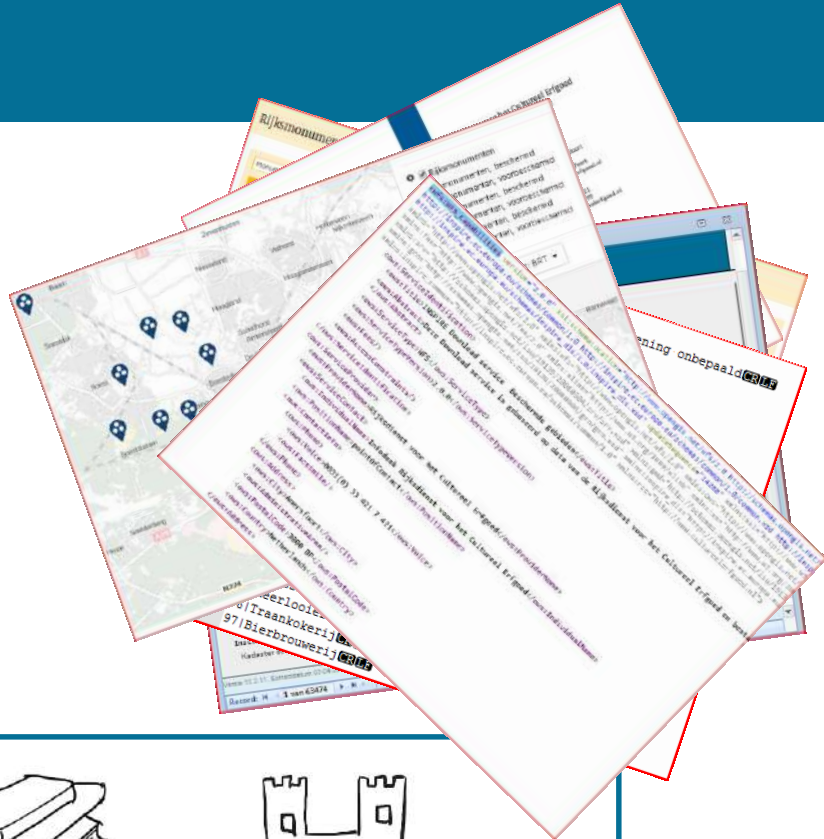

experimenting

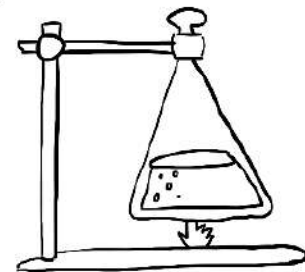
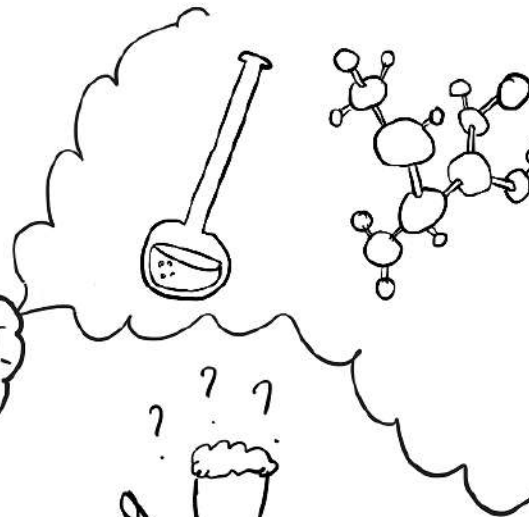
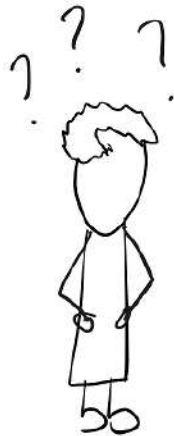

2011

127.0.0.1:

getting serious



Rijksdienst voor het Cultureel Erfgoed
Ministerie van Onderwijs, Cultuur en
Wetenschap



Aan de slag met de
Omgevingswet

Erfgoed
Monitor



kadaster



Dienst Uitvoering Onderwijs
Ministerie van Onderwijs, Cultuur en
Wetenschap



MRS

Archis

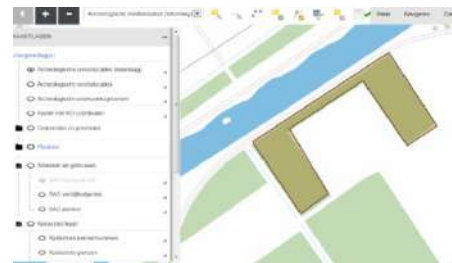

data.overheid.nl

we are getting serious



2015 - ontology



2016 - thesauri



2017 - data

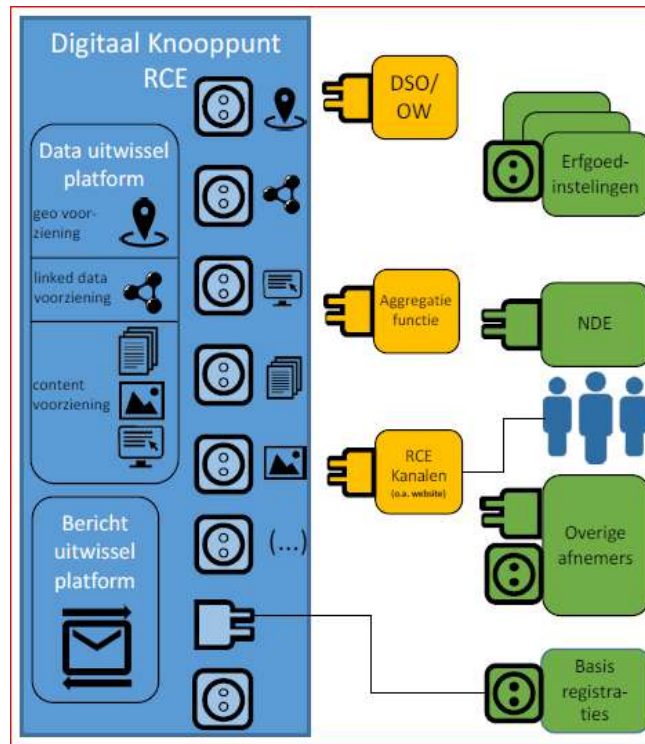

Architecture

necessary

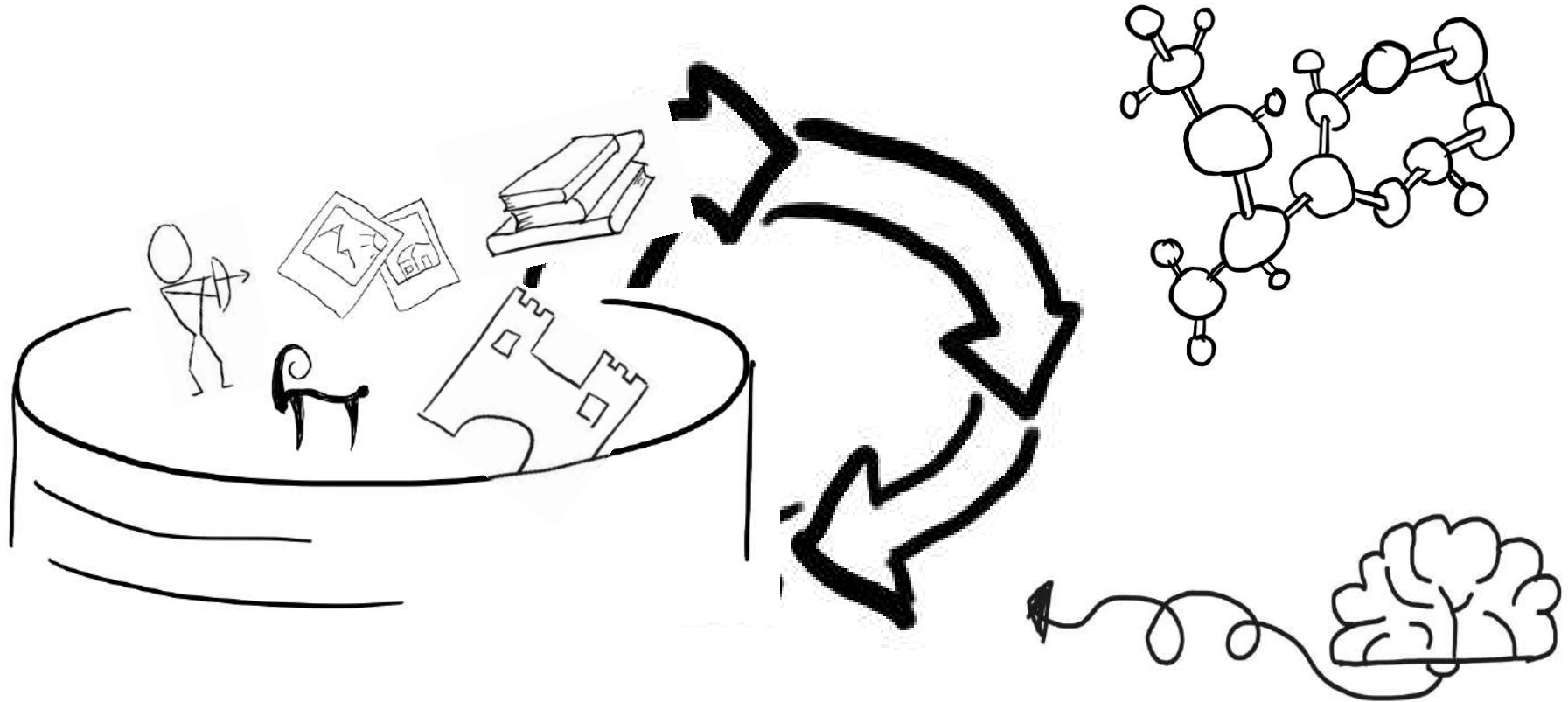

proof of concept

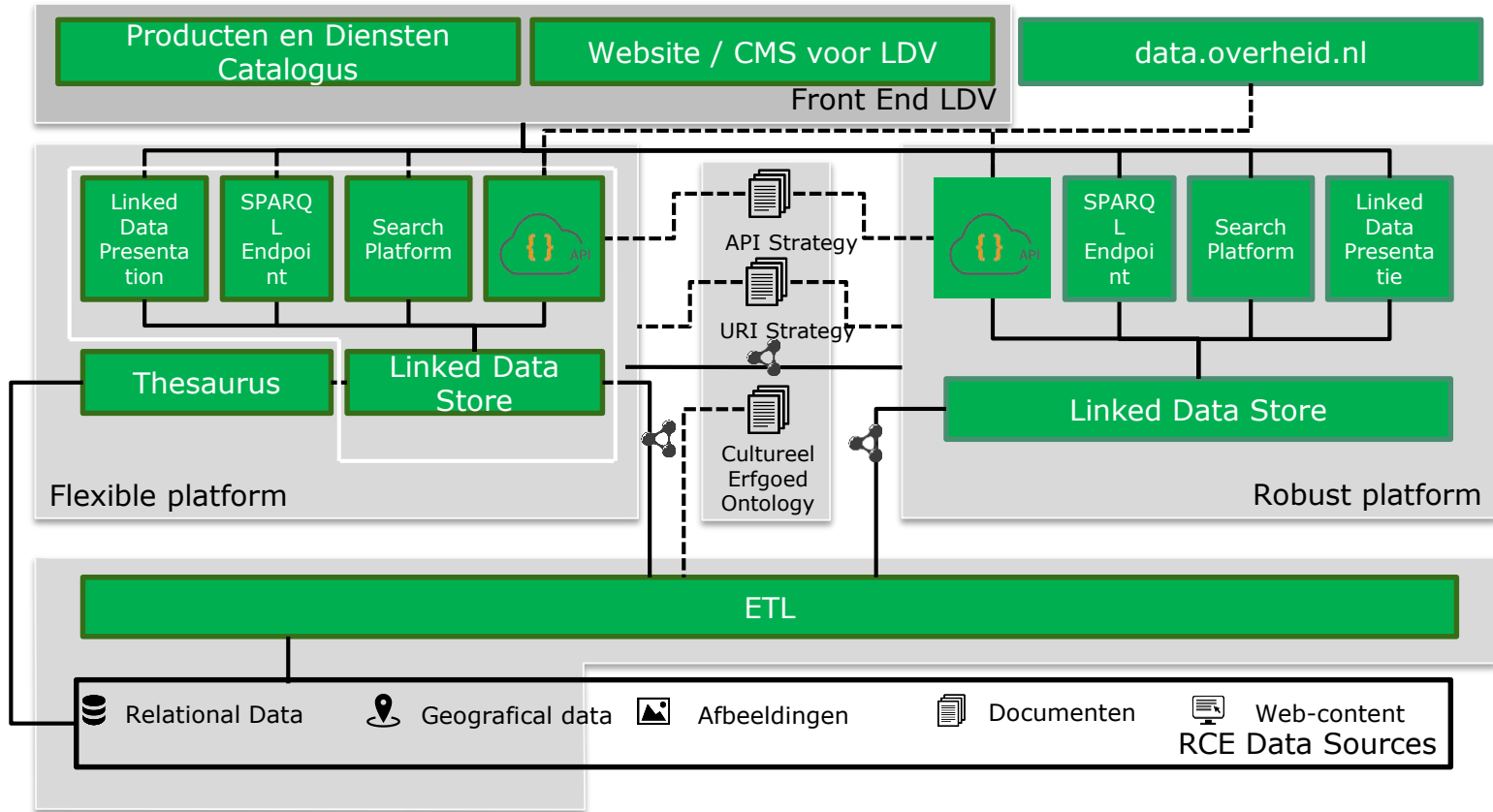



CHOI

KENNIS

ZAAK

Monumentnummer: 5 Besiendershuis Oudezijds Achterburgwal 31 1012 DA te Amsterdam

Actualiteit gegevens: 22-12-2017

Monumentgegevens

Monumentnummer:	5
Monumentnaam:	Besiendershuis
Status:	rijksmonument
Inschrijving register:	26 maart 1970
Kadaster deel/nr:	4475/87
Internationaal Kenteken:	Nee

Locatie

Provincie:	Noord-Holland
Gemeente:	Amsterdam
Woonplaats:	Amsterdam
X-Y coördinaat:	121807 - 487452

Omschrijving

Pand met halsgevel (kort na 1701), wijzigingen (XVIIIc). Fronton met schelp. Vormt groep met nrs 33, (35) en 37.

Adressen

Hoofdadres	Straat	Nr	Toev.	Postcode	Situering	Locatie	Woonplaats
Ja	Oudezijds Achterburgwal	31		1012 DA			Amsterdam

Oorspronkelijke functies

Hoofdfunctie	Functiesoort	Functiecode	Categorie	Subcategorie	Functie	Bijzonder	Toelichting
Ja	oorspronkelijke functie		Woningen en woningbouwcomplexen	Woonhuis(K)	Woonhuis		



ceo: Cultureel Erfgoed Ontologie (CHOI + KENNIS)

zaak: Zaak ontologie (ZAAK)

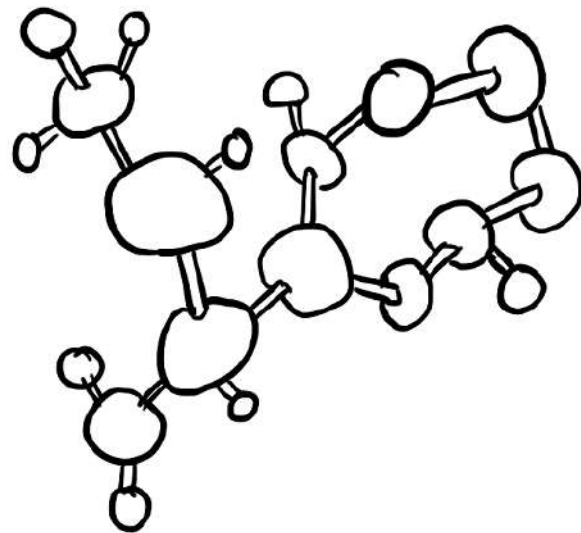
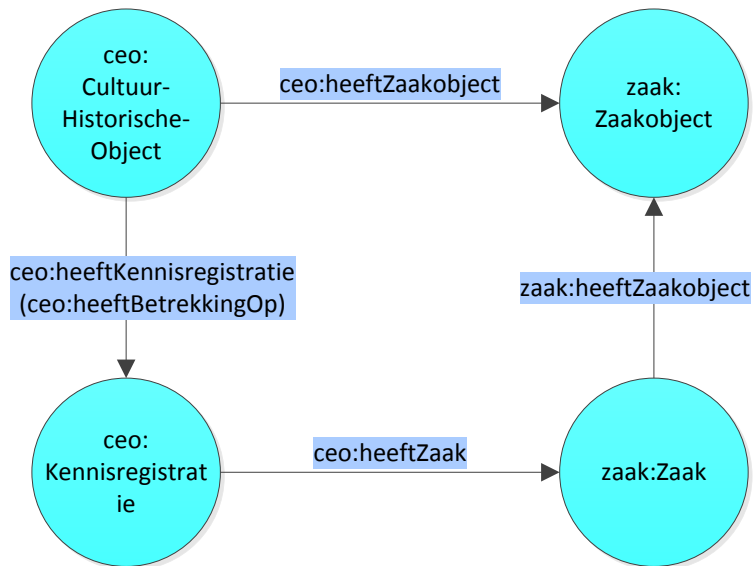

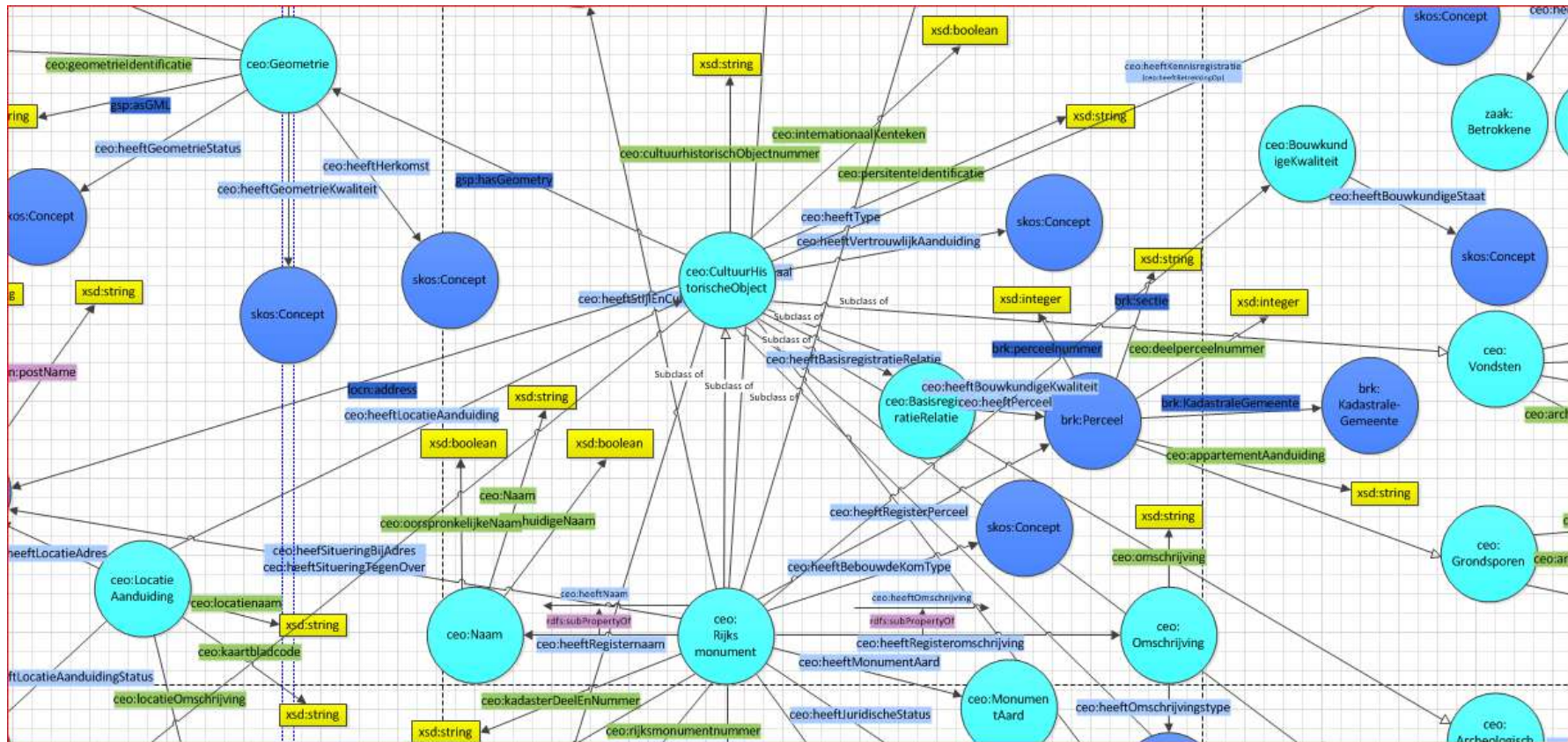

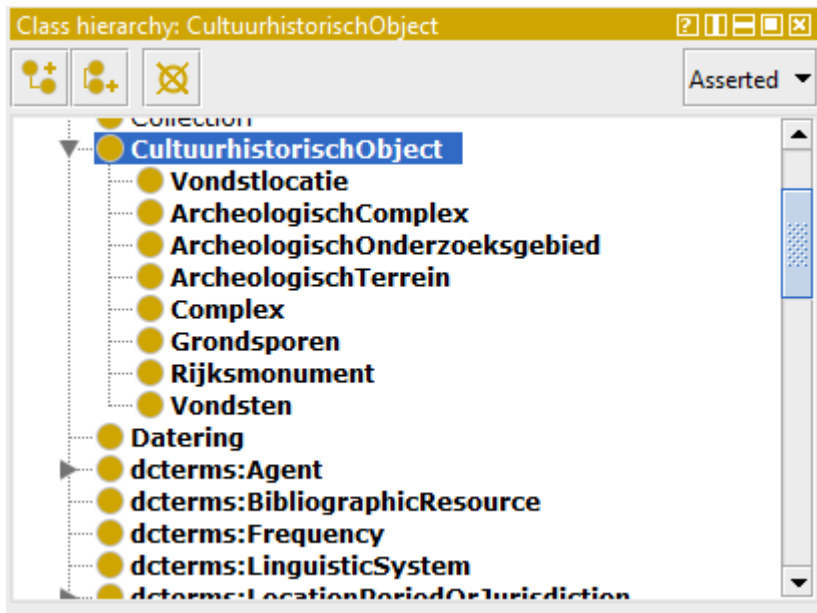

37 classes

96 ObjectProperties

58 Dataproperties

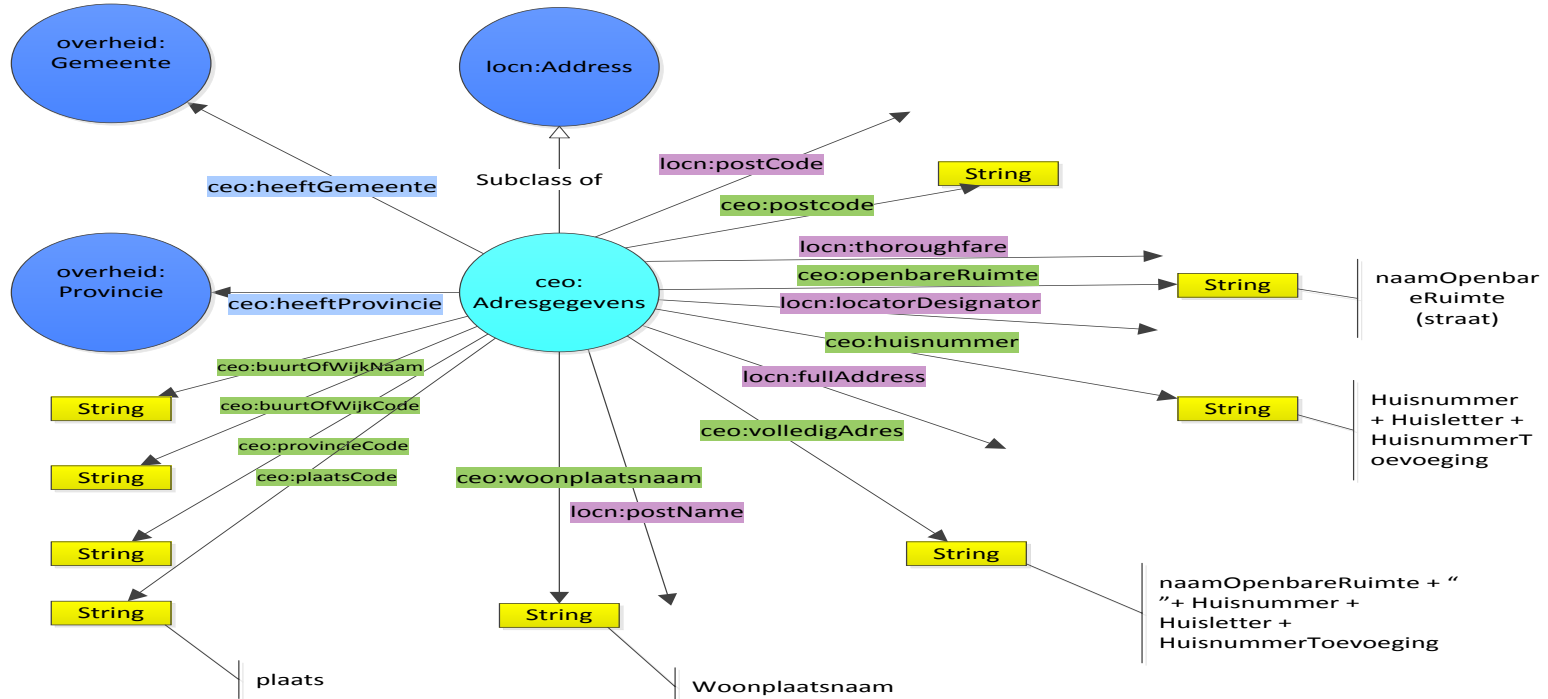

N.B. Voorlopig geen land gemodelleerd pas in latere fase, als andere landen in data wordt gemodelleerd .

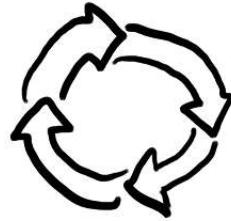

linked data

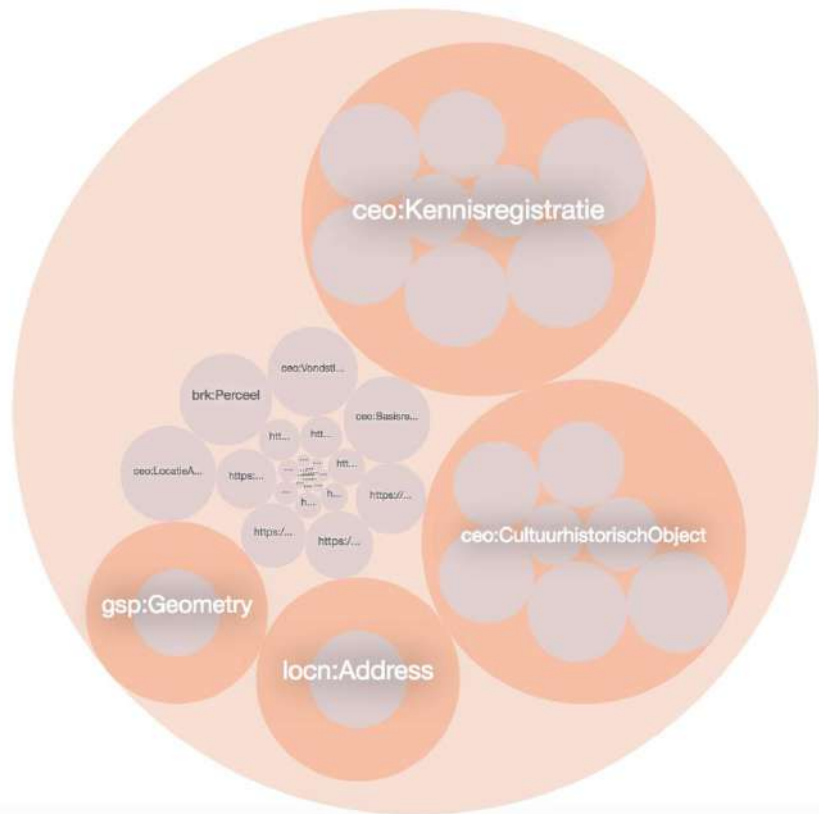

total statements:	42.097.656
explicit:	34.162.617
inferred:	7.935.039

linked data

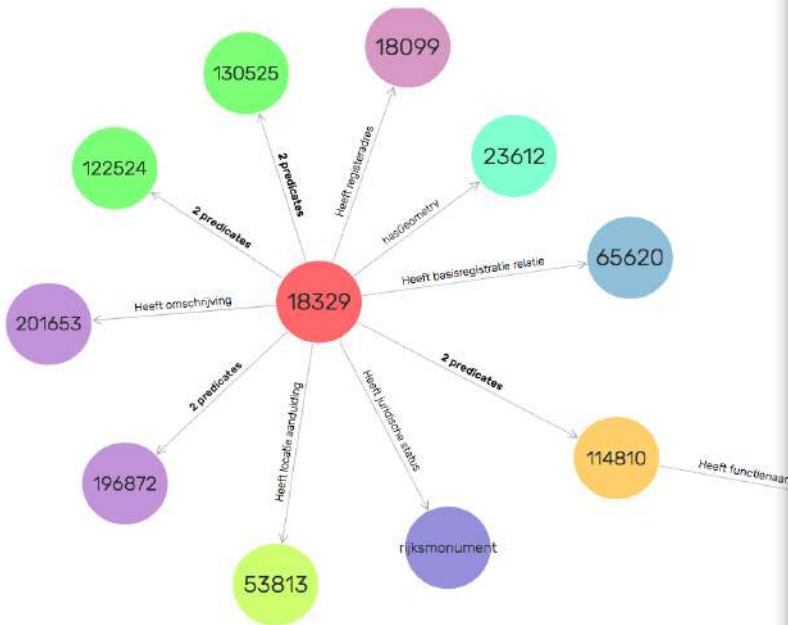

etl-repo-local

Woonhuis(K)

Woonhuis(K)^{nl}

Types:

- skos:Concept
- <https://data.cultureelerfgoed.nl/vocab/id/rn#BultEnvir>
- <https://data.cultureelerfgoed.nl/vocab/id/rn#MrsConce>

RDF rank:

0

Search instance properties

<https://data.cultureelerfgoed.nl/vocab/id/rce#hasCode>
K7

<https://data.cultureelerfgoed.nl/vocab/id/rn#hasChtSameAs>
woonhuizen

skos:hiddenLabel
K7

linked data

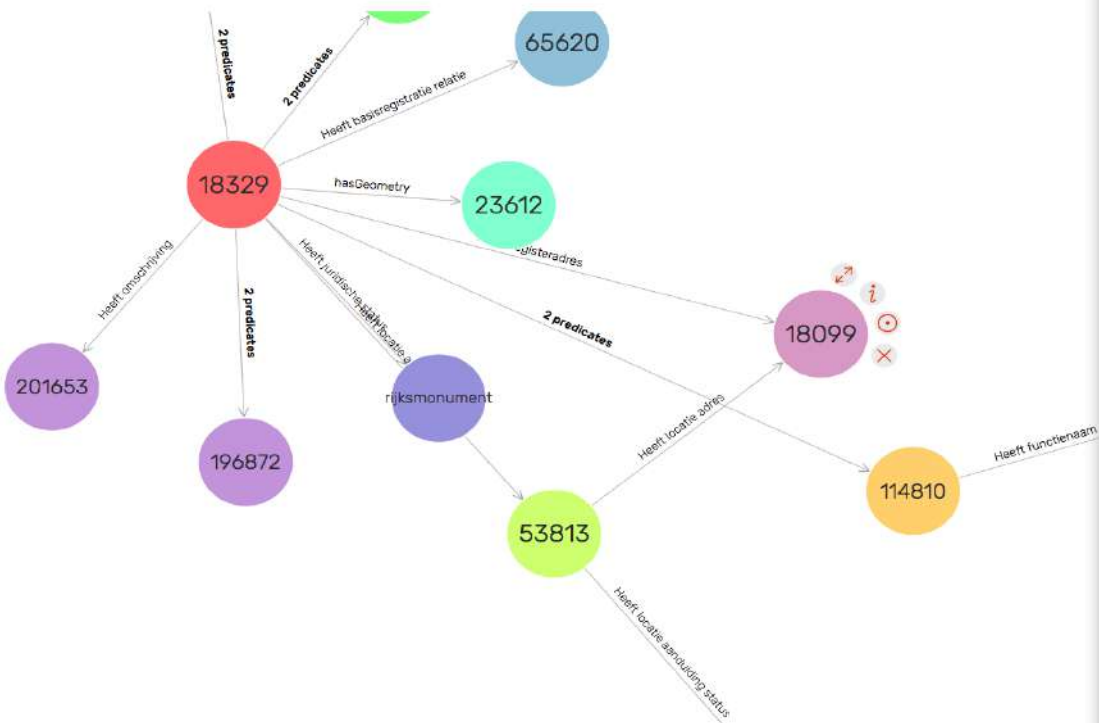

etl-repo-local

18099

18099

Types:

ceo:Adresgegevens

RDF rank:

0

Search instance properties

locn:fullAddress
Prins Hendriklaan 50

locn:locatorDesignator
50

locn:postCode
3583EP

locn:postName
Utrecht

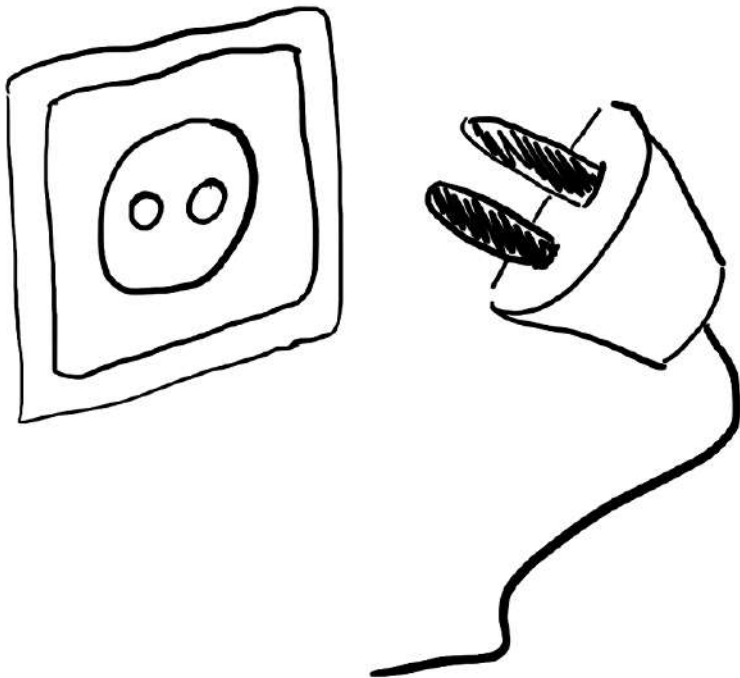

```
{
  "rijksmonumentnummer": "18329",
  "naam": null,
  "complexnummer": null,
  "registerComplexNaam": null,
  "omschrijving": "In 1924 door de architect G.Th.Rietveld voor mevrouw Schroder-Schrader gebouwd WOONHUIS, waarin door een abstracte architectuur van gepleisterde vlakken de principes der Stijlgroep op sublieme wijze tot uitdrukking zijn gebracht.<n>",
  "complexomschrijving": null,
  "heeftFunctie": [
    {
      "https://data.cultureelerfgoed.nl/term/id/rn/5692c4a0-0ede-4dd5-bcbd-fc2a373f3973"
    }
  ],
  "heeftJuridischeStatus": "https://data.cultureelerfgoed.nl/term/id/rn/b2d9a59a-fe1e-4552-9a05-3c2acddff864",
  "locn": {
    "thoroughfare": "Prins Hendriklaan",
    "locatorDesignator": "50",
    "postCode": "3583 EP",
    "postName": "Utrecht"
  },
  "brk": {
    "plaats": "Utrecht",
    "gemeente": "http://standaarden.overheid.nl/owms/terms/Utrecht_(gemeente)",
    "provincie": "http://standaarden.overheid.nl/owms/terms/Utrecht_(provincie)"
  },
  "geometrie": {
    "type": "Point",
    "coordinates": [
      5.14750797134445,
      52.0853169363687
    ]
  },
  "_links": {
    "self": {
      "href": "https://data.acceptatie.pdok.nl/api/rce/v1/rijksmonumenten/18329",
      "title": "Rijksmonument 18329"
    },
    "percelen": [
      {
        "href": "https://data.acceptatie.pdok.nl/api/rce/v1/percelen/122524",
        "title": "Perceel 4211"
      },
      {
        "href": "https://data.acceptatie.pdok.nl/api/rce/v1/percelen/130525",
        "title": "Perceel 3230"
      }
    ]
  }
}
```

OpenAPI Specification (OAS) 3.0

telling the story

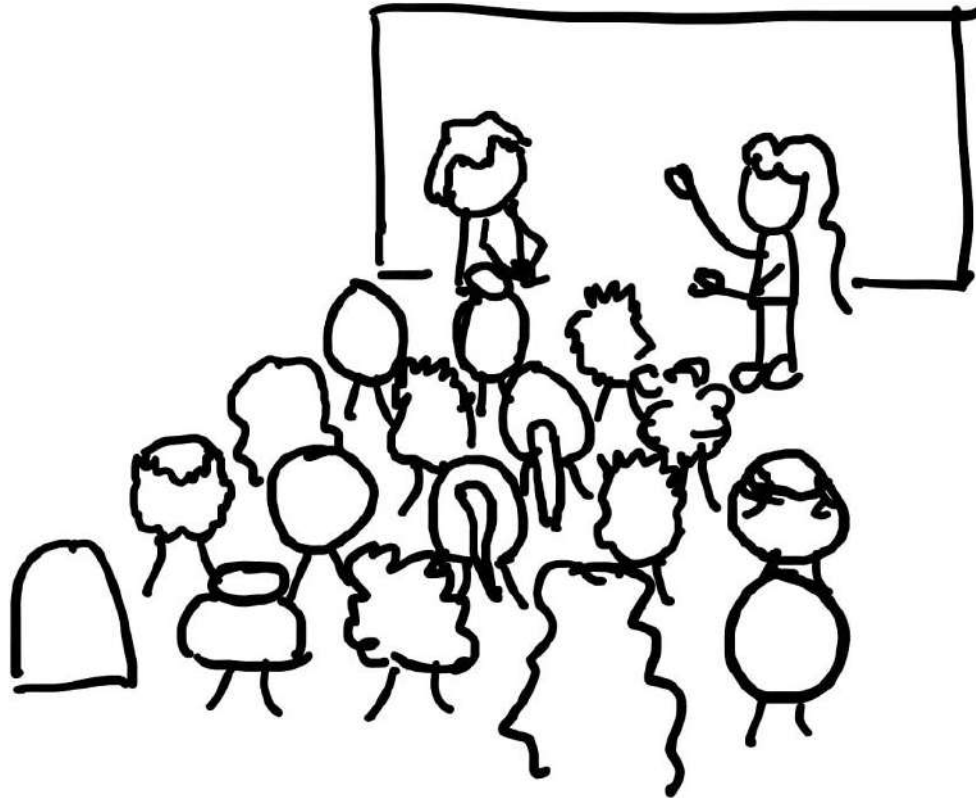

story policy plans



Zoek Bedrijfslocatie

Nijmegen, Nijmegen

Bierbrouwen

SBI-2008: 1105

Omgevingsradius: 3

Milieucategorie: 4.2

Vestigen

Vestiging object toegestaan vanwege geïdentificeerde locatie met radius van 300m gelokaliseerd binnen grenzen van functioneelgebied bedrijfstreets.

Omgevingsinformatie

Plaats: Westkanaaldijk

Type Omgeving: Functioneel/Gebied, Bedrijfsstermin

Categorie: werk gebied

Milieucategorie: Min: 3.1 Max: 4.1

Bestemmingsplangebied

naam: Feortbestemmingsplan Archeologie

naamoverheid: gemeente Nijmegen

plangebied: NL.IMRO.0268.FBPArcheologie-0401

planstatus: ontwerp

typeplan: bestemmingsplan

verwijzingsaankort: [hmi](#), [hmi](#)

dossierstatus: geheel onherroepelijk in werking

Vestigen toegestaan

Legenda

- Vestigen toegestaan
- Onbemand
- Vestigen niet toegestaan
- Bevraagd object binnen gekozen SBI
- Bestemmingsplangebied

200 m | 2000 m



Jein!

- Open ends ETL
- Daily struggle ontologists
- Flexible part
- Published LD
- API
- Follow-up



[Home](#) [Actueel](#) [Raadplegen](#) **[Checken](#)** [Aanvragen](#)

[Home](#) | [Checken](#)

4. Resultaat

Stap 4 van 4

Resultaat 'Sloopwerkzaamheden uitvoeren'

Slopen van een bouwwerk of gedeelte van een bouwwerk: vergunningplichtig

[← Vorige stap](#)

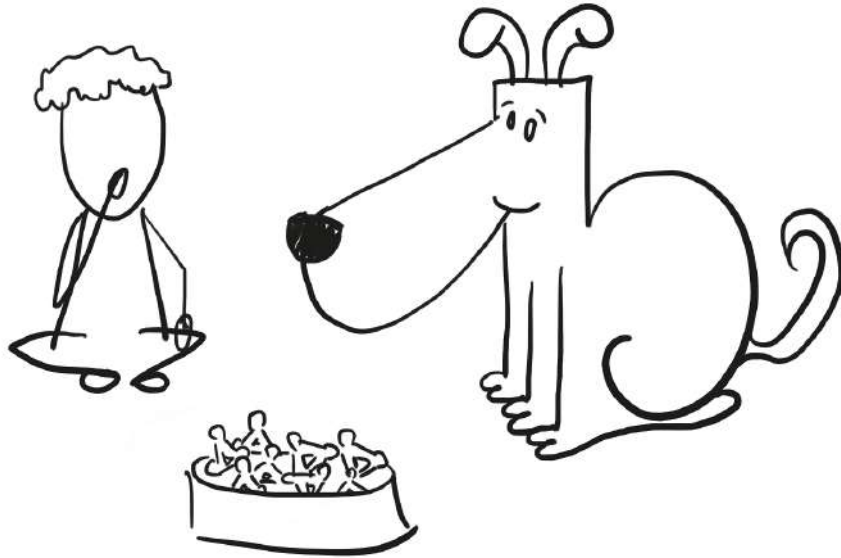

- Ontologies
- API
- Flexible platform
- Live 1-12-2018
- ETL
- New content
- Eating our own dogfood





Rijksdienst voor het Cultureel Erfgoed
*Ministerie van Onderwijs, Cultuur en
Wetenschap*

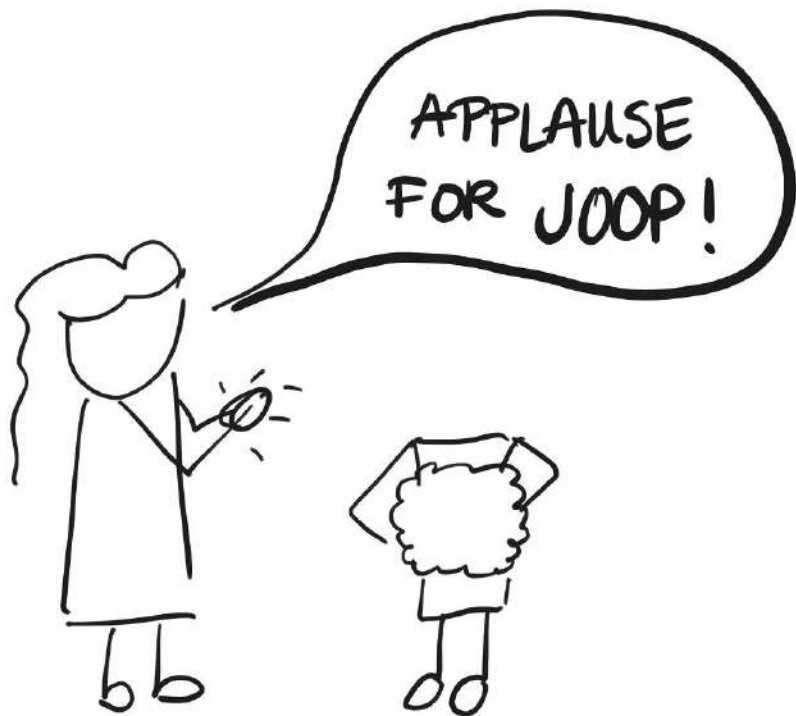

Joop Vanderheiden

mail: j.vanderheiden@cultureelerfgoed.nl
linkedin: [jvand64](#)

Anna Schakel

mail: a.schakel@cultureelerfgoed.nl
linkedin: [annaschakel](#)

Steven van Klei (ETL)

mail: Steven.vanKlei@OneFox.nl

Frans van der Zande (Ontology)

mail: f.van.der.zande@cultureelerfgoed.nl